

# Twist II Clean

Filter your water for longer equipment life.

The **Twist II Clean** filter is an inline filter designed to remove organics, sand and sediment from your water supply.

Used to filter water before entering equipment, the **Twist II Clean** filters have many unique and patented features and benefits placing them in a class of their own.

- Simple 1/4" turn operation
- Filter element flushes completely clean in less than 20 seconds
- No need to turn off water to clean (eliminates air in system)
- Rugged design installs indoors or outdoors
- Stainless steel filter element lasts for years
- Never buy filter cartridges again!



## Patented Reverse Flushing Action

When the top handle is turned, three events take place:

- 1 Flow direction is changed to inside-out
- 2 The filter element is lifted to open the bottom flush port
- 3 An inside-out backwash occurs, and the filter element is cleaned

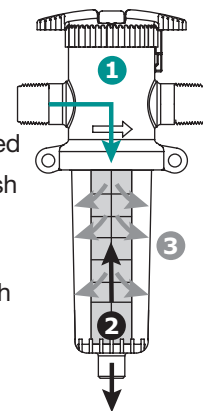

Often Used



irrigation



vehicle care



industry



food processing



horticulture



animal health



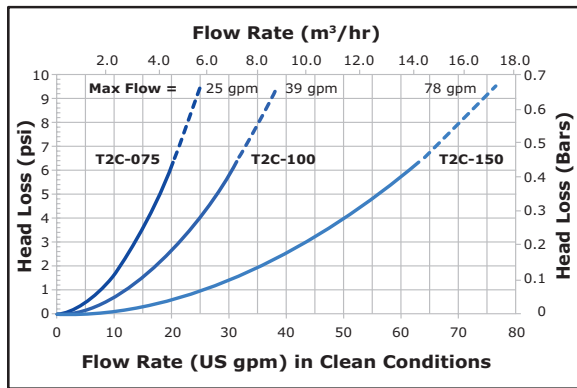

# Further Information

## Technical Specifications:



— = recommended flow range

### Mesh Size Available:

-  30 Mesh (600 Micron) Element (Brown)
-  60 Mesh (250 Micron) Element (White)
-  100 Mesh (150 Micron) Element (Gray)
-  140 Mesh (105 Micron) Element (Black)
-  200 Mesh (74 Micron) Element (Blue)

## Dimensions:

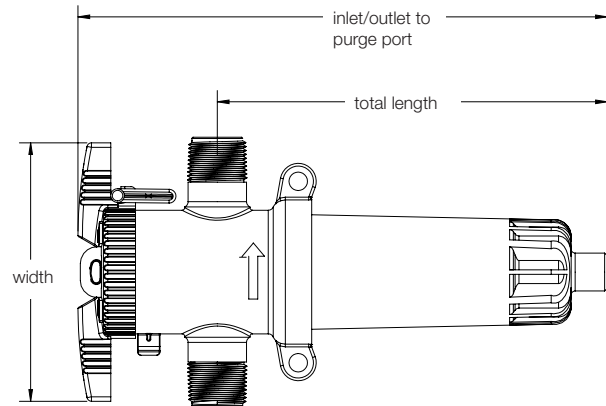

## Chart

Model	Description	Filter Screen Size		Max Operating Pressure		Inlet/ Outlet Pipe Connection	Purge Outlet	Total Length	Length (inlet/ outlet to purge port)	Width (inlet/ outlet)
		Mesh	Micron	psi	bar					
017004	T2C 3/4" 105 Micron NPT	140	105	100	7	3/4" NPT	1/2" NPT	11 3/4"	8 3/4"	6"
017003	T2C 3/4" 150 Micron NPT	100	150	100	7	3/4" NPT	1/2" NPT	11 3/4"	8 3/4"	6"
017002	T2C 3/4" 250 Micron NPT	60	250	100	7	3/4" NPT	1/2" NPT	11 3/4"	8 3/4"	6"
017001	T2C 3/4" 600 Micron NPT	30	600	100	7	3/4" NPT	1/2" NPT	11 3/4"	8 3/4"	6"
017008	T2C 1" 105 Micron NPT	140	105	100	7	1" NPT	1/2" NPT	11 3/4"	8 3/4"	6"
017007	T2C 1" 150 Micron NPT	100	150	100	7	1" NPT	1/2" NPT	11 3/4"	8 3/4"	6"
017006	T2C 1" 250 Micron NPT	60	250	100	7	1" NPT	1/2" NPT	11 3/4"	8 3/4"	6"
017005	T2C 1" 600 Micron NPT	30	600	100	7	1" NPT	1/2" NPT	11 3/4"	8 3/4"	6"
017011	T2C 1.5" 105 Micron NPT	140	105	100	7	1.5" NPT	3/4" NPT	15"	12"	8"
017014	T2C 1.5" 150 Micron NPT	100	150	100	7	1.5" NPT	3/4" NPT	15"	12"	8"
017013	T2C 1.5" 250 Micron NPT	60	250	100	7	1.5" NPT	3/4" NPT	15"	12"	8"
017012	T2C 1.5" 600 Micron NPT	30	600	100	7	1.5" NPT	3/4" NPT	15"	12"	8"
015760	T2C 2" 75 Micron Flange	200	75	100	7	2" Flange	3/4" NPT	24"	12"	8 1/4"
015700	T2C 2" 105 Micron Flange	140	105	100	7	2" Flange	3/4" NPT	24"	12"	8 1/4"
015710	T2C 2" 150 Micron Flange	100	150	100	7	2" Flange	3/4" NPT	24"	12"	8 1/4"
015720	T2C 2" 250 Micron Flange	60	250	100	7	2" Flange	3/4" NPT	24"	12"	8 1/4"



**North America**  
3798 Round Bottom Road  
Cincinnati, Ohio, 45244  
**Phone** 513.271.8800  
**Toll Free** 800.543.7184  
**Fax** 513.271.0160  
**Web** hydrosystemsco.com

**Europe**  
Unit 3 The Sterling Centre  
Eastern Road, Bracknell  
Berkshire, RG12 2PW  
**Phone** +44 (0)1344 488880  
**Fax** +44 (0)1344 488879  
**Web** hydrosystemseurope.com

**South America**  
Av. Prefeito Luiz Latorre, 9.401  
Distrito Industrial  
Jundiaí SP  
CEP: 13209-430  
Brazil  
**Phone** +55 12 3201 7707  
**Web** hydrosystems.com.br

**Australia**  
Unit A, 1 Kellham Place  
Glendenning, NSW 2761  
Australia  
**Phone** +612 9625 8122  
**Fax** +612 9625 8177

**Asia Pacific**  
No. 1555, Cenglin Road,  
Pudong District, Shanghai  
201306, China  
**Phone** +86 21 61871037  
**Toll Free** 400-600-4026  
**Fax** +86 21 68727775  
**Web** hydrosystemschina.com